

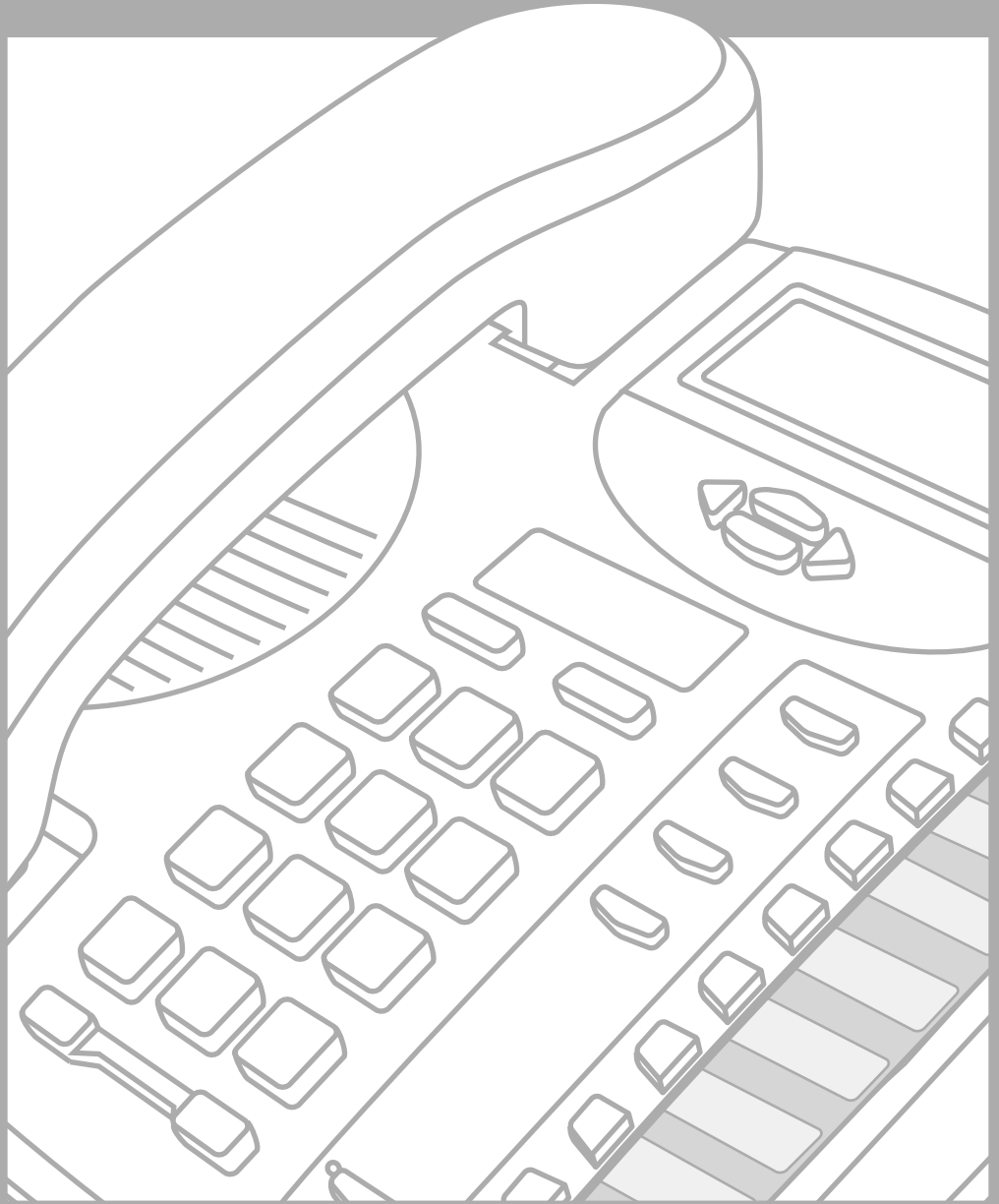

ASTRA

9116 User Guide



Introduction 2

Emergency Service Feature 2

Unpacking your phone 2

Key Descriptions 3

Basic Installation 5

Making and Answering Calls 8

Making a call 8

Answering a Call 8

Using the Hold Key 8

Making a Handsfree call 8

Muting a handsfree call 9

Using Redial 9

Call Waiting ID 9

Changing the display language 10

Setting the date and time 10

Adjusting the Handset and Speaker volume 10

Adjusting the Ringer Volume 10

Adjusting the Display Contrast 11

Set Indicator Light 11

Directory 12

Saving numbers and names to the Directory 12

Entering Names 13

Making a call from the Directory 13

Finding items in the Directory 13

Deleting items from the Directory 14

Callers List 15

Using the Callers List 15

Finding an item in the Callers List 15

Making a call from the Callers List 15

Editing in the Callers List 15

Memory keys 17

Saving numbers and names into memory keys 17

Viewing memory key contents 17

Labeling the memory keys 18

Making calls from memory keys 18

Deleting memory keys 18

Saving features in memory keys 19

Using feature keys 19

Advanced Features 20

Clear Message Waiting 20

Set Area Code 20

Display Icons and Messages 21

Icons in the Caller List 21

Display messages 21

Troubleshooting 22

Introduction

Congratulations..... on the purchase of your 9116 telephone.

This guide contains operating information for your 9116.

The 9116 is an advanced single-line telephone, that offers the following features:

- Handsfree (speakerphone) with mute capabilities
- 80 name and number Callers List
- Personal Directory for 20 name and number directory
- 15 speed dial positions for frequently called numbers or feature access codes
- Last number redial



Emergency Service Feature

The Model 9116 will provide basic telephone service during a power failure. However, only the dial pad, ringer and handset will function. If on a handset call when a power failure occurs, the Model 9116 will keep the call. Handsfree calls will not be re-established during a power interruption.

Unpacking your phone

Along with this user guide and the feature card, the following items are included with your telephone.

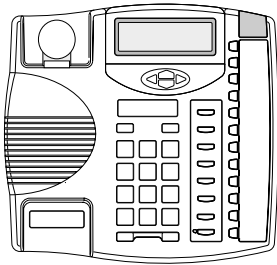

Telephone

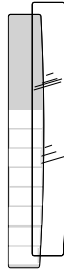

Memory key card and plastic lens



Handset



Handset cord



Number card and plastic lens



Power adaptor

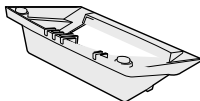

Telephone stand



Telephone line cord









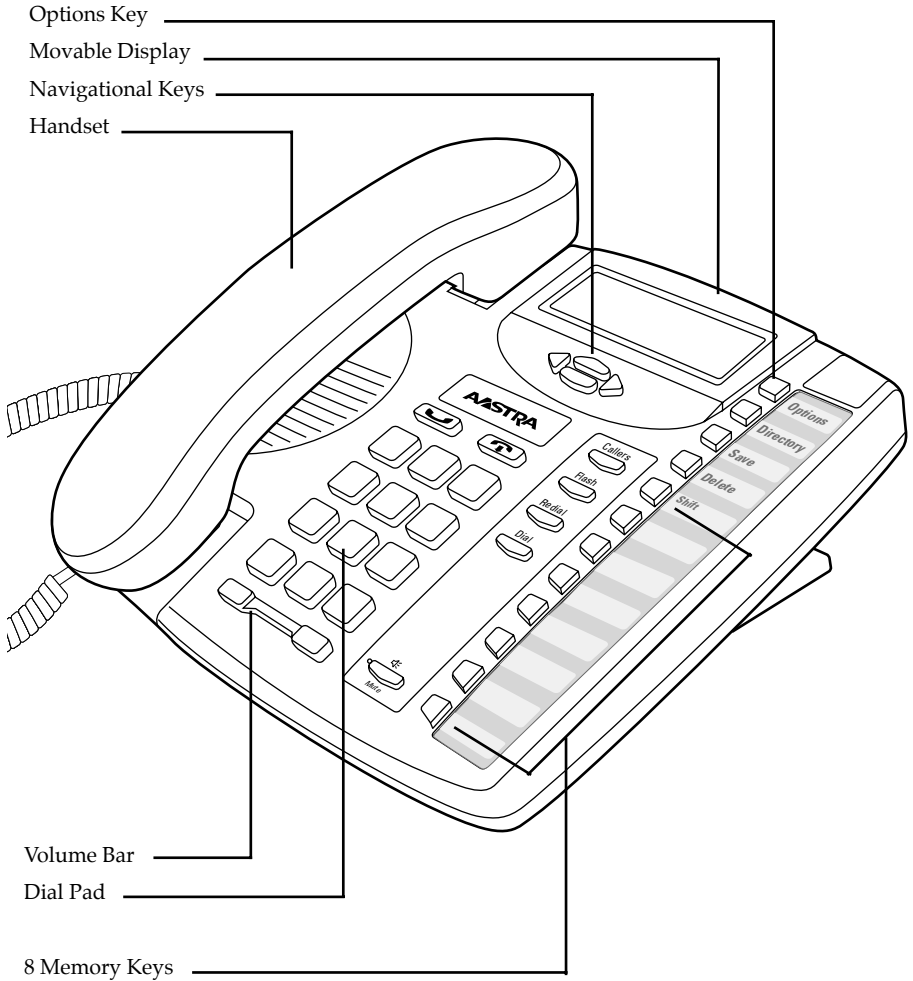







Regulatory sheet

The power adaptor is 9V DC, 300mA - please see the regulatory sheet for safety in instructions regarding the power adaptor and operation of the telephone.

Key Descriptions



Keys	Key Description
Set Indicator Light	Flashes when the telephone rings, or when a call is on hold; lights up when a message is waiting or when a feature or extension is in use. See Set indicator light messages on page 11 for more information.
8 Programmable Keys	Stores a name and number or feature for easy access.
<input type="checkbox"/> Options	Access a list of 5 options to customize the features of your telephone .

Keys	Key Description
	Stores up to 20 names and phone numbers. See Directory on page 12 for more information.
	◀ ▶ allows you to move up or down in the Directory, Callers List, Options List and the Redial List. When you are editing entries on the display, ◀ adds a space when entering or editing names or numbers ▶ allows you to view multiple messages on the telephone display or adds a space between characters.
	Ends an active call. Goodbye exits an open list, such as the Directory, Options or Callers List. It will not hang up a call that is on hold.
	Places calls on or off hold. See Using the Hold Key on page 8 for more information.
	Sets the handset and speaker volume while on call.
 and light indicators	Activates the speaker and microphone so you can listen and talk without using the handset; also mutes the microphone so that your caller cannot hear you (the light indicator will flash when the microphone is muted) .
	Accesses a list of the last 80 calls received. The list begins with the newest call and ends with the oldest. The oldest call is automatically deleted to make room for the new calls when the list becomes full. See Callers List on page 15 for more information
	Use with the network features such as Call Waiting and Three Way Calling (flash is also referred to as link).
	Displays the last number dialed out on the telephone. See Using Redial on page 9 for more information.
	Dials the displayed telephone number, automatically activates the handsfree mode if the handset is not picked up.
	Use to store numbers and names in Directory, in memory keys and to access and save Option feature settings.
	Removes individual entries in the Directory, or Callers List. Erases memory key information.
	Use to access the eight two-touch memory positions.
	Memory keys store numbers, names and features. See Memory keys on page 17.

Basic Installation

1. Connect the Handset

Attach one end of the coiled handset cord to the handset and the other end to the handset port  on the back of the telephone.

Route the handset cord along the groove leading off the side of the telephone as shown in the illustration.

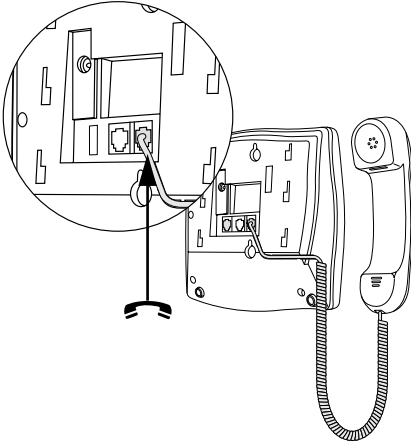

2. Connect the Cords

Plug one end of the telephone cord into  on the back of the telephone and the other end to the phone jack.

Connect the small end of the power adaptor to the  port on the back of the telephone, and plug the other end into an electrical outlet.

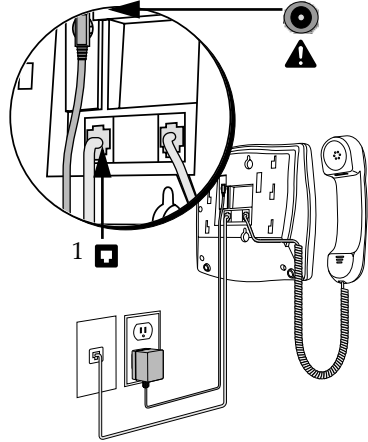

3. Attach the Stand for Desk Mount

If you plan to mount the telephone on the wall, you do not need to attach the stand.

Lower the stand as shown below into the slots on the back of the telephone.

Slide the stand in the direction shown below until it clicks into the locked position.

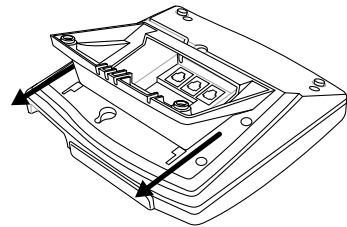
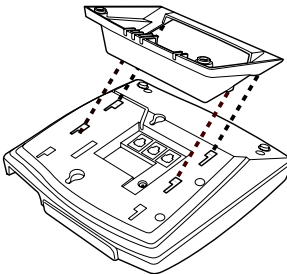

6. Attach the cords to the telephone stand

Route the cords along the groove on the telephone stand as shown in the illustration.

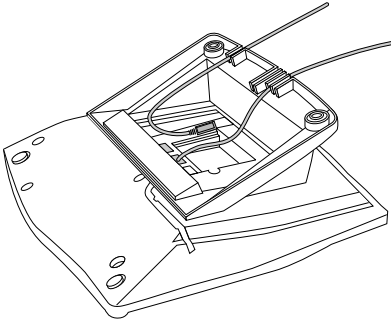

7. Mount the telephone on the wall

It is recommended that you use a wall-mounting plate which is available through your telephone company or a local retailer. You will find it easier to wall-mount the telephone if you purchase one short 20 cm (8") telephone cord and use it in place of the long telephone cord.

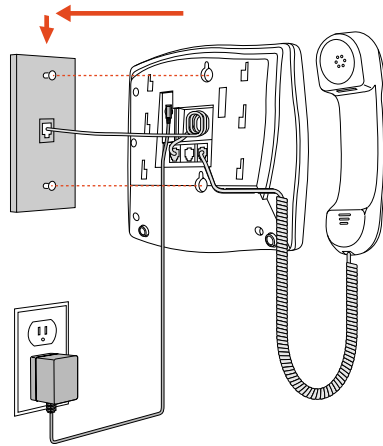

Coil the telephone cord(s) into the space provided on the back of the telephone.

Line up the keys on the wall mounting plate with the key holes on the back of the telephone.

Place the telephone onto the wall mounting plate, and then push down to secure the telephone into place.

8. Insert the number card on your telephone

Write your telephone number on the number card.

Place the number card into the slot underneath the handset cradle on the on the telephone.

Gently bend the clear plastic lens and place it on top of the number card in the slot.

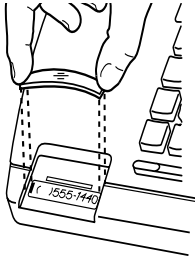

9. Insert the Memory key card on your telephone

This card contains the feature names for the dedicated keys and label identification spaces for the eight programmable memory keys.

Place the card into the memory key card slot on the telephone.

Gently bend the clear plastic lens and place it on top of the memory key card in the slot.

For more information on programming memory keys, refer to **Memory keys** on page 17



To avoid potential electrical shock hazard to personnel or damage to the telephone, use **only** the manufacturer-supplied equipment and installation procedures. Specifically, use only 4 conductor modular teledapt plug/ cords with this product, and an AC transformer that is CSA/UL or CSA-NRTL/C approved Class 2 level C, rated as follows:

For North American Markets AC voltage 110-120V, Input: 120VAC, 60Hz, 10W and Output: 9V DC, 300mA.

Substitution of non-approved equipment will void the Aastra Telecom Inc., warranty. For more information about installation and safety concerns, call 1-800-574-1611.

Making and Answering Calls

Making a call

With your telephone you can make and answer calls using your handset or  for speakerphone capabilities.

To make a regular call:

1. Lift the handset or press .
2. Enter the number using the dial pad.

Answering a Call



To answer a call:

1. Lift the handset or press .

When you subscribe to the Caller ID service from your telephone company, Caller ID information is sent from the telephone company to your 9116 telephone between the first and second ring. Therefore, if you want the telephone number of the incoming call to appear on the display and in the Callers List, you must wait until the information appears on the display before answering the telephone.

Using the Hold Key

To put a call on hold and take a call off hold:



1. Make or answer a call.
2. Press . The set indicator light will flash quickly to indicate there is a call on hold.
3. To retrieve the call, press  or . If you don't retrieve the call within 15 minutes, the call is automatically dropped.

Note: The 9116 automatically releases a call on hold when a person on an extension telephone on the same line picks up the call. If you don't hang up the handset after you have put a call on hold and that call is picked up by someone at another extension, the call is taken off hold but remains connected to your telephone. If this happens, any background noise from your area will be heard by the caller and the person at the other extension.



Making a Handsfree call

You don't have to use the handset to use your telephone. Instead, you can use Handsfree mode to place a call, or you can switch to Handsfree mode while a call is in progress.

To dial without picking up the handset:

1. Press .
2. Enter the number using the dial pad.
3. When the call is over, press .

To switch to a Handsfree call:

1. Lift the handset.
2. Dial a number using the dial pad.
3. When the call is answered, press .
4. Hang up the handset.
5. When the call is over, press .



Muting a handsfree call



You can turn off the microphone so that the caller can't hear you but you can still hear the caller. Muting a call only works when you are in Handsfree mode.

To mute a handsfree call:

1. Press .

2. Without lifting the handset, make a call.

3. To turn off the microphone, press . You can hear your caller but your caller cannot hear you. The light beside  flashes.

4. To speak to your caller, press  again. Each time you press , you turn the microphone on or off.



5. When the call is over, press .

Using Redial

Pressing Redial displays the last number dialed. When you press  the last number you called appears on the screen.

To make a call using Redial:



1. Press . The display shows the last number you dialed.

2. Lift the handset or press either  or .

Call Waiting ID[†]

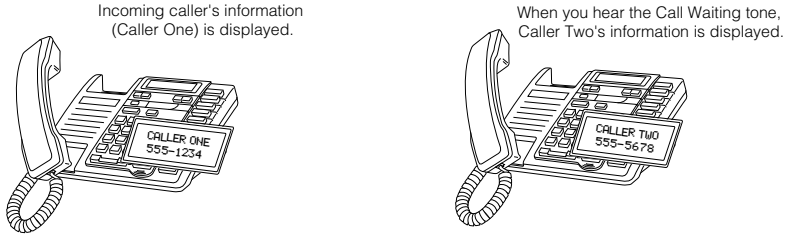
The 9116 is capable of displaying Caller ID information of a second incoming call while you have a call in progress. When you are on a call and you hear the Call Waiting tone, the Call Waiting information is displayed as shown below.







If you decide you want to speak to the new caller, simply press . Your first call will not be disconnected. You may switch between callers as often as you like by pressing . When you press  and see a caller's Identification information but only hear a dial tone, it means that the caller has hung up. Your second call will be stored in the Callers List even if it is not answered. For more information about stored calls, see **Callers List** on page 15.

[†] You must subscribe to your telephone company for the Call Waiting with Calling ID service.

Changing the display language

For changing business requirements, you may wish to change the language of your display messages and prompts. There are three language choices available for your telephone (English, French and Spanish).









To change the display language:

1. Press  *Options* . **Set Language** appears on the display.
2. Press  *Save* . The language indicators **E**, **F** ,**S** appear on the display for English, French and Spanish. The current selection is indicated by the flashing letter.
3. Use  or  to change the selection.
4. Press  *Save* .

Setting the date and time

If you subscribe to the Caller ID service from your telephone company, the date and time are set automatically after you receive your first incoming call. If you do not subscribe, you must set the date and time manually.

To set the date and time:

1. Press  *Options* .
2. Press  once. Display indicates **Set Time/Date**.
3. Press  *Save* . Display shows time and date. Use  and  to adjust the flashing time and date and   to move to the next field. To change the AM/PM indicator, adjust the time ahead by 12 hours.
4. Press  *Save* .

To resume the automatic date and time setting (if the date and time has been set manually), disconnect the power supply, then re-connect it. After your first incoming call, the date and time are automatically set if you subscribe to the Caller ID service from your telephone company.

Adjusting the Handset and Speaker volume

Press the left or right side of the volume bar  to adjust the volume on the handset or speaker. The volume remains at the level selected until the next time you change it.

Adjusting the Ringer Volume

The ringer volume is controlled by a three position switch on the back of the Model 9116. The ringer volume can be set to be off, low or high.



Adjusting the Display Contrast

The contrast on the display screen can be adjusted as required to compensate for lighting conditions.

To adjust the display contrast:

1. Press  *Options* .

2. Press  once. Screen displays **Set Contrast**.

3. Press  *Save* . Display shows - - - - - +. Use  and  to move the flashing line to adjust the contrast to the desired level.

4. Press  *Save* .

Set Indicator Light

The set indicator light, located on the top right hand corner of the Model 9116, flashes and illuminates to provide information as follows:

Set indicator light is on.	Extension phone is in use.
Set indicator light flashes very quickly.	Incoming call.
Set indicator light flashes quickly.	Line is on hold.
Set indicator light double flashes.	Message Waiting*.

* You must subscribe to Voce Mail features from your telephone company for this feature to work.

Directory



The 9116 telephone directory can store the names and telephone numbers of up to twenty of your business associates, clients, contacts, friends and relatives for easy dialing.

Each directory record is numbered and identified by the number appearing in the bottom, right hand corner of the screen display. Names and numbers can be manually entered into the Directory using the keypad or transferred into the Directory from the screen display.



If all twenty directory records are used, the display will indicate **DIRECTORY FULL**. (See **Deleting items from the Directory** on page 14).

Saving numbers and names to the Directory

To save or edit a number and name:

1. Press  *Directory*. The screen displays directory record 1. Use the  or  if this directory record is already used or you wish to store this entry under another directory record number.

2. Press  *Save*. The screen prompts you to enter the phone number you wish to save.

3. Enter the number using the dial pad. You can enter a maximum of 16 digits. If you need to add a pause (for example between a telephone number and an access code) press  and the Pause icon will appear. To program a number that uses Flash, press the  key where required and the Flash icon will appear.

4. Press  *Save*. The screen prompts you to enter the name you wish to save. Use the dialpad to enter a name. See **Entering Names** on page 13.

5. Press  *Save*. The display shows **SAVED:DIRECTORY**.

6. Press  to exit the Directory.

To save from the display:

1. Ensure that a number is on the display (for example from the Callers List).

2. Press  *Save*. The screen shows **ENTER NUMBER**.

3. Press  *Save* again. The screen indicates **ENTER NAME**. If there is already a name associated with the number or you do not wish to have a name with this directory entry, go to the next step. Use the dialpad to enter the name if required. See **Entering Names** on page 13.

4. Press  *Save* again. Display shows **SAVED TO?**





5. Press  *Save*.

6. Press  *Directory*. The screen indicates **SAVED: DIRECTORY** and the entry is saved in the next available directory record.









7. Press  to exit the Directory.

Entering Names













You can program names to correspond with numbers you have entered into the Directory or a memory key. The following paragraphs explain how to enter letters using the dial pad. Before you can use the dial pad to enter names, you must first save or edit a number in the Directory or memory key.

To program a name, find the dial pad key that has the first character of the name. Keep watching the display as you press the key until that character appears on the display. Press a different dial pad key for the next character. If the next character is on the same key, press  to move to the next space or wait a few seconds and it will automatically advance to the next space. To insert a space, press . To backspace and erase a mistake, press  and  *Delete*.

For example, to enter the name RUTH press these keys:

        .



If you wish to change a digit or letter after you have entered it, press  to erase it.



 , - . 1	 A B C 2	 D E F 3
 G H I 4	 J K L 5	 M N O 6
 P Q R S 7	 T U V 8	 W X Y Z
 *	 0	 #

Making a call from the Directory



To make a call from the Directory:

1. Press  *Directory*.

2. Press  or  or use the dial pad to find the item you want to dial out.

3. Lift the handset or press either  or .



4. To end the call, press  or hang up.



Note: To leave the Directory at any time, press  *Directory* or .

Finding items in the Directory

To find items in the Directory:







1. To see the Directory List heading, press  *Directory*.

2. Use the  and  to look at each individual directory entry one at a time.





3. To leave the Directory at any time, press  *Directory* or .

Deleting items from the Directory

To delete individual items:

1. Press  *Directory*.
2. Press   to find the item you want to delete.
3. Press  *Delete* twice. The screen indicates **EMPTY**.
4. Press  or  to exit the Directory at any time.

To delete all items:

1. Press  *Directory*.
2. Press and hold  *Delete* until the screen indicates **DELETE ALL?**
3. Press  *Delete* again to confirm deletion of the entire Directory.
4. Press  .

Callers List[†]

Using the Callers List



The 9116 telephone stores up to 80 calls in the Callers List. Your telephone logs the number (and name if available) of the caller, when they last called, and the number of times they tried to reach you. When the Callers List is full, the oldest call records are deleted to accommodate the information of new callers. See **Callers List display messages** on page 21 for a description of the display messages.



If the telephone number of the incoming call matches a number that you have programmed with a name in a memory key or the Directory, the Callers List shows the name you have saved in the memory key or Directory, and the number.

Finding an item in the Callers List

To find items in the Callers List:

1. Press . The display shows the most recent caller record.

2. Press  to view other caller records one at a time starting from the second most recent caller. To view from the oldest caller record to the most recent press . The screen may display **END OF LIST** but continue to press  to see the oldest call record.



3. Press  or  to leave the callers list.

Making a call from the Callers List

To dial a number in the Callers List:

1. Press . The display shows the most recent caller record.

2. Find the caller record you wish to dial to.

3. Lift the handset or press either  or .

4. To end the call, press  or hang up.

If you call a number from the Callers List and you don't get connected, you may have to edit the number (for example, the number may be long distance and you may have to add "1").









Editing in the Callers List

Note that you cannot save changes made to a phone number in the Callers List. If you plan to dial the number again, it is recommended that the number be saved in the Directory or Memory Key first so that changes can be saved for redialing purposes.







Tip: If you frequently have to remove area codes to return local calls, use the Area Codes option to avoid this situation. See **Set area code**, page 20, for more information.

[†] You must subscribe to your telephone company for the Caller ID service.





To edit a number in the Callers List:

1. Press .
2. Press  keys to find the Caller record you wish to edit.
3. Press . The screen indicates **ENTER NUMBER** for about one second and the first digit of the telephone number flashes to indicate the position of the cursor.
4. Use the dial pad to add digits. Added digits will appear to the left of the cursor. Press  to erase a digit and all digits to the right of the cursor will move one position to the left. To add a pause press . To add a Flash feature to a number, press .
5. To dial the edited number, immediately lift the handset or press  or  as soon as editing of the number is complete.
6. To save the edited number in the Directory rather than dialing it, go to step 4 below.



To copy a number from the Callers List to the Directory or to a memory key:

1. Press .
2. Press  keys to find the Caller record you wish to copy.
3. Press . The screen indicates **ENTER NUMBER**.
4. Press  again. The screen indicates **ENTER NAME**. If there is already a name associated with the number or you do not wish to have a name with this entry, go to the next step. Otherwise, use the dialpad to enter the name. See **Entering Names** on Page 13..
5. Press . Display shows **SAVED TO?**.
6. Press  to save the Caller Record in the next available directory record. The screen indicates **SAVED: DIRECTORY**.
7. To save to a memory key rather than the Directory, press a memory key position (or  plus a memory key) and the screen shows **SAVED: MEMORY KEY**.

Deleting from the Callers List**To delete a number in the Callers List:**

1. Press .
2. Press the  to find the Caller Record you wish to delete.
3. Press  twice very quickly to delete the record.
4. Press  or  to exit the Callers List or simply wait a few seconds and the phone automatically exits the Callers List.

To delete all numbers in the Callers List:

1. Press .
2. Press and hold  until the display indicates **DELETE ALL?**
3. Press  again and the display briefly will indicate **NO CALLS**.

Memory keys

Saving numbers and names into memory keys

You can save up to 15 speed dial numbers and names of your customers, business associates, or anyone you call frequently in 9116's eight memory keys. You can store more numbers and names in the Directory. See the **Directory** on page 12 for more information.

To save or edit a number and name in a memory key:

1. For a one touch memory key, press any of the seven lower memory keys. The screen will show **EMPTY** or whatever name and number have already been programmed into the memory key. For a two touch memory key, press the *Shift* (display will show **SHIFT**) and then one of the memory keys.

2. Press *Save*. Display indicates **ENTER NUMBER**.

3. Enter the number using the dialpad. You can enter up to 16 digits. To add a pause to a number, press *Redial*. To add Flash to a number, press *Flash*.

4. Press *Save*. Display indicates **ENTER NAME**. If you do not wish to add a name for the Memory key, go to the next step. To add a name, use the dialpad. See page 14, **Entering Names**.

5. Press *Save*. The display shows **SAVED: MEMORY KEY**.

Note: You can also program a memory key by copying a caller record in the Callers List. See page 16, **To copy from the Callers List**.

Viewing memory key contents

To view an item in the memory key:

1. Press the memory key or the *Shift* plus the memory key to view the contents of that key.

2. Display screen will show any number and name programmed to that key. Display will briefly indicate **EMPTY**.



Labeling the memory keys

Your Memory key card has label identification spaces (shaded in grey) for each of the eight programmable memory keys. Write the name of the autodialer or feature on these spaces when you program a memory key.





Making calls from memory keys

To call from a memory key:

1. Lift the handset or press  or .
2. Press the memory key, or  plus the memory key to obtain the number you wish to dial.

To predial from a memory key:

1. Press the memory key, or  plus the memory key to obtain the number you wish to dial.
2. Lift the handset or press either  or .

Deleting memory keys

To delete a memory key:

1. To see its contents, press the memory key.
2. To erase, press  twice.

Saving features in memory keys[†]

For easy access, you can save the feature codes of telephone company services in your memory keys. This works well with network features such as Call Forwarding and Call Return. Some features require an On and Off code in two separate keys, while other features are stored on only one key. The following procedures show you how to save both an On and Off code.

To save a Feature On code:

1. Press the memory key where you want to save the number.

2. Press Save .

3. Enter the telephone company feature code for turning the feature on.[†]

- Read the display to confirm the number.

4. Press Save .

5. Enter the feature name using the dial pad. (See **Entering Names** on page 13.)

6. Press Save .

7. Label the memory key.

To save a Feature Off code:

1. Press the memory key where you want to save the number.

2. Press Save .

3. Enter the telephone company feature code for turning the feature off.[†]

- Read the display to confirm the number.

4. Press Save .

5. Enter the feature name using the dial pad. (See **Entering Names** on page 13.)

6. Press Save .

7. Label the memory key.



[†]**Note:** Contact your telephone company for the appropriate feature codes.

Using feature keys

When a memory key is programmed with a feature code, you can use the memory key to activate or deactivate the feature.

To turn a feature on or off:

1. Press the memory key where you stored the desired feature. The display shows the feature name and code.

2. Lift the handset or press either  or  .
The feature code is dialed out, which turns the feature on or off.

[†]You must subscribe to your telephone company for Custom Calling Features.

Advanced Features

Clear Message Waiting

On occasion, the display will indicate MESSAGE WAITING even though there are no messages in your Voice Mail service. You can use the following procedures to clear the display.

To clear Message Waiting indication:

1. Press  *Options* .

2. Press  button twice. Screen shows MESSAGE WAITING.

3. Press  *Save* . Screen indicates CLR MSG WAITING?

4. Press  *Delete* .

Set Area Code





The 9116 allows you to save one up to three digit area code that will be stripped when dialing a number from the Callers List.. For example, if you enter your own area code using this option, any Callers List entries with your same area code will be dialed as a seven digit number, even though they will appear on the display with the area code showing. For example, let's assume your area code was 111, and you set this area code using this option. Any number in the Callers List with the same 111 area code would be dialed out from the Callers List as a seven digit number, without dialing the area code. Note that the number would still appear in the Callers List and on the display with the full number, but when dialed would appear on the first line of the display screen as a seven digit number.

To set the area code:

1. Press  *Options* .

2. Press  three times. Display shows SET AREA CODE.

3. Press  *Save* . Display indicates three positions - - -.





4. Use  and  to select a digit. Use  and  to move to the next position.

5. Press  *Save* .

Display Icons and Messages

The Model 9116 telephone has a three-line display that uses both icons and text messages to supply call information.

Icons in the Callers List

	Voice message waiting [†]
	Phone is not in use
	Phone is in use
	Incoming call
	Incoming call waiting call [†]

[†]This service may have a different name in your area. Contact your telephone company for information.

Display messages

Here are some common screen display messages. For more information on other display messages, check the appropriate section of this user guide when using the telephone.

Message	What it means
XX NEW CALL	XX new calls have been added to the Callers List since last checked.
DIRECTORY FULL	All locations in the Directory are used.
MESSAGE WAITING	Voice message waiting.
EMPTY	No item stored in the Memory key.
END OF LIST	You are at the end of the Callers List.
DELETE ALL?	Prompt to delete all Directory or Callers List entries.
ENTER NUMBER	Prompt to enter a telephone number for saving in Directory or Memory Key.
PRIVATE CALL	Caller has requested their caller information to be suppressed.

Troubleshooting

The display is in the alternate language.

See page 10 for instructions to change the display language.

The cursor doesn't move when saving in the Directory.

The number or name is too long. Numbers and names can be no longer than 16 characters.

There is no information on the display and the ringer volume is low.

Make sure the power adaptor is plugged in to a working electrical outlet.

I cannot hear a caller.

Make sure the handset cord is inserted securely into the jack and make sure the receiver volume is high enough.

The power is out and the display is blank.

The 9116 still operates as a regular telephone during a power failure. You can dial using the dial pad and you can receive calls, but the other keys and the display do not operate until the power is restored.

The telephone wobbles.

Check that the handset cord is placed in the channel between the stand and the telephone. See the illustration on page 6.

I cannot program a memory key.

Some of the memory keys may be factory-programmed. These keys are locked and cannot be erased or reprogrammed.

Callers are not identified on the display.

Let the telephone ring at least twice before answering. If that doesn't work, you may not have a Calling Line Identification[†] service. To subscribe, contact your local telephone company.

The Callers List is empty.

Until you subscribe to Calling Line Identification[†] service, your telephone does not record incoming calls. Also, the Call Log option may be set to log no calls.

I cannot dial a number in the callers list.

The caller may have an unknown number.

The display is blank on my phone.

Check that the power adaptor is connected to the phone, and that the phone is connected to a working outlet. You can test the outlet with another device, such as a lamp.

How do I answer Call Waiting?

To answer a Call Waiting call, press . You may have to subscribe to a Call Waiting[†] service to use this feature.

[†] This service may have a different name in your area. Contact your telephone company for information.

- A**
 - Answering a call 8
 - Area codes 20
- C**
 - Call Waiting Identification 9
 - Callers List 15
 - deleting in 16
 - editing 15, 16
 - finding items 15
 - making a call 15
 - copying to the Directory or a memory key 16
 - Calling
 - from a memory key 18
 - from the Callers List 15
 - from the Directory 13
- D**
 - Date and time 10
 - automatic 10
 - setting 10
 - Deleting
 - Directory items 14
 - items in the Callers List 16
 - memory keys 18
 - Directory 12
 - deleting items 14
 - entering names 13
 - finding items 13
 - making a call 13
 - saving numbers and names 12
 - Display
 - contrast 11
 - language changing 10
 - messages 21
- E**
 - Editing
 - the Callers List 15, 16
 - the Directory 12
- H**
 - Handsfree 8
 - Hold 8
- L**
 - Language
 - see Display language 10
 - Letters
 - entering 13
 - Lights
 - set indicator light messages 11
- M**
 - Memory keys 17
 - deleting 18
 - editing 18
 - labeling 18
 - making calls from 18
 - saving features 19
 - saving numbers and names 17
 - Mute 9
- N**
 - Names entering 13
- O**
 - Options 10, 11, 20
- R**
 - Redial 9
- S**
 - Saving
 - feature codes to memory keys 19
 - from Callers List
 - to Directory or memory key 16
 - Set indicator light messages 11
 - Setting
 - date and time 10
 - ring tone and volume 10
- T**
 - Troubleshooting 22
- V**
 - Voice Mail 11, 21
 - Volume 10
 - handset 10
 - ringer 10
 - speaker 10



GENERAL INQUIRIES

If you have read the guide and you still have questions, call 1-800-574-1611 in Canada and the USA. In other areas, contact your telephone company.